

# HILTI

## UW 10

**Bedienungsanleitung**

**de**

**Operating instructions**

**en**

**Mode d'emploi**

**fr**

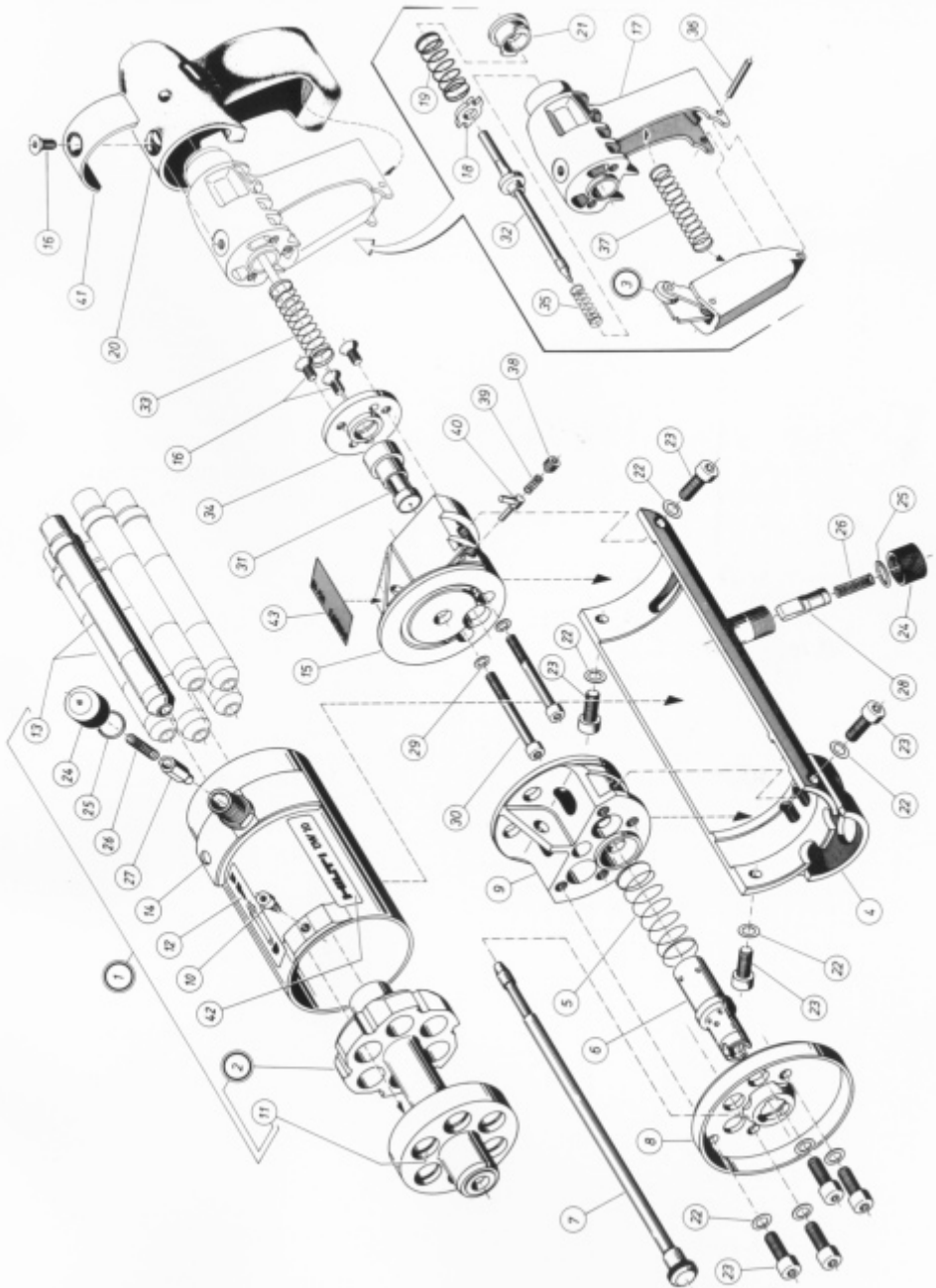

2

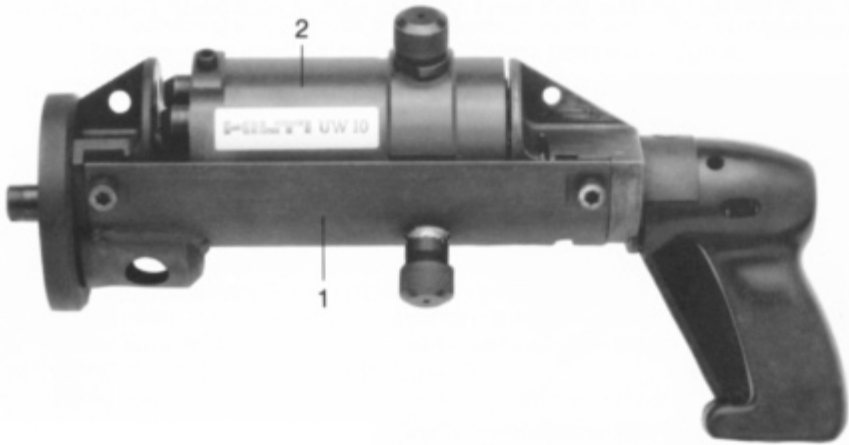

3



4



# ORIGINAL OPERATING INSTRUCTIONS

# UW 10 underwater powder-actuated tool

*It is essential that the operating instructions are read before the tool is operated for the first time.*

*Always keep these operating instructions together with the tool.*

*Ensure that the operating instructions are with the tool when it is given to other persons.*

## Spare parts drawing 1

### Description of main parts 2

- ① Basic tool body
- ② Revolving magazine

### Tool components 3

### Tool case and list of contents 4

#### Equipment consists of:

Consec. no.	Item no.	Pieces	Ordering designation
1	3574	1	UW 10 case complete
2	3539	1	UW 10 tool
3	3508	1	Rev. magazine
4	59179	1	Screwdriver 4, DIN 911
5	51052	1	Screwdriver 5, DIN 911
6	59182	1	Screwdriver 6, DIN 911
7	8205	1	Ejector
8	9355	1	Round brush 8 mm dia.
9	3206	1	Flat brush
10	9354	1	Cleaning cloth
11	3552	1	UW 10 spares pack
12	3546	1	Tube Molycote 111
13	308976	1	Hilti-Spray
14	21002	100	Threaded studs EM 6 H-20-20M F8
15	3544	100	Sealing caps UWDK
16	3570	1	Contents leaflet
17	3577	1	Operating instructions
18	3574	1	Case UW 10
20	3570	1	Contents leaflet
21	3577	1	Operating instructions

Contents	Page
1. General Information	13
2. Description	14
3. Insert tools and accessories	14
4. Consumables, spare parts	15
5. Safety precautions	16
6. Manufacturer's warranty – DX Tools	18
7. Operation	19
8. Before use	21
9. Care and maintenance	22
10. Maintenance	23
11. Troubleshooting	24
12. Disassembly instructions	37
13. Assembly instructions	40

## 1. General Information

**1** The numbers refer to the illustrations. The illustrations can be found on the fold-out cover pages. Keep these pages open while you read the operating instructions. In these operating instructions, the designation "the tool" always refers to the UW 10 Underwater powder-actuated tool.

## 2. Description

### 2.1 Tool

The Hilti UW 10 is a high-performance powder-actuated tool i.e. a high-velocity tool without a piston, which has a stud magazine and a cartridge magazine. This tool has been specially designed by Hilti for ship repair and other underwater applications.

### 2.2 Field of application

The UW 10 powder-actuated tool is for fastening repair plates to the hulls of ships, above the water line. Other underwater applications are also possible

### 2.3 Technical data

Weight:	6.7 kg above water, 5.7 kg under water
Length:	390 mm
Height:	205 mm
Driving power:	600 Joule with yellow cartridge *) 1100 Joule with red cartridge *)
Power regulation:	2 cartridge power loads
Contact pressure:	100 N
Cocking distance:	17 mm

\*) Applies to tool with EM 6H-20-20 M8 threaded stud

### 2.4 Tool case

#### 2.4.1 Technical data

Outside dimensions: 420×306×125 mm  
Weight: empty 2.1 kg, full 12.6 kg  
(with tool, kit and consumables,  
but without cartridges)

#### 2.4.2 Description

This is a commercially available Hilti case made of red ABS cadmium-free plastic. It has a carrying handle and two catches. It comprises a lid and base which close together in such a way that the contents are protected against sprayed water. The internal compartments ensure that the tool, equipment and kit are held in the case and do not shake about.

## 3. Insert tools and accessories

### 3.1 Tools and consumables



Consec. no.	Item no.	Quantity	Ordering designation
①	59179	1	Screwdriver 4, DIN 911
①	51052	1	Screwdriver 5, DIN 911
①	59182	1	Screwdriver 6, DIN 911
②	9355	1	Round brush 8 mm
③	3206	1	Flat brush
④	8205	1	Extractor
⑤	308976	1	Hilti-Spray
⑥	3546	1	Tube Molycote 111

### 3.2 Accessories

Item no.	Ordering designation
3577	Operating instructions
3570	Contents leaflet
3552	UW 10 spares pack consisting of:

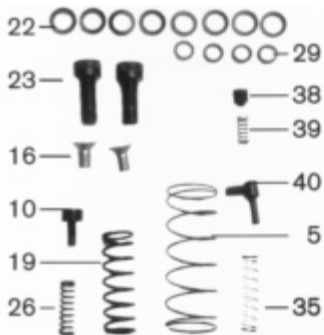

Consec. no.	Item no.	Quantity	Ordering designation
22	8622	8	Schnorr washer 8
29	70489	4	Schnorr washer 6
23	1163	2	Hexagon socket screw M8×22
16	3540	2	Hexagon socket screw M6×12
38	8773	1	Set screw M8×8
40	8753	1	Detent assy.
39	8771	1	Spring 0.63×5.5×12
5	3536	1	Spring 1×23.3×63
35	6148	1	Spring 0.4×7.4×31.8
26	0225	1	Spring 0.9×6.9×24.1
19	6151	1	Spring 1.4×14.9×42.4
10	3548	1	Hex skt screw M6×10.5

(The consecutive numbers are identical to those in the drawing **1**)

en

## 4. Consumables, spare parts

### 4.1 Consumables



Consec. no.	Item no.	Pack-aging contents	Ordering designation
①	21002	100	Threaded stud EM 6 H-20-20M F8
②	3544	100	Sealing caps UWDK yellow, DM 31 yellow red, DM 41 red
③	50378	48	Cartridges 9×17W yellow
③	50379	48	Cartridges 9×17W red

## 4.2 Spare parts for UW 10 tool

Spare parts which are unsuitable for the purpose of the UW 10 tool must not be used. Non-observance can result in loss of warranty coverage. Hilti declines any liability for damage or loss which could arise from non-observance of this precaution. (The consecutive numbers are identical to those in the drawing .

Consec. no.	Item no.	Qty.	Ordering designation	Consec. no.	Item no.	Qty.	Ordering designation
1	3508	1	Revolving magazine	20	3526	1	Grip covering
2	3506	1	Drum assy.	21	3527	1	Cover
3	6106	1	Trigger assy.	22	8622	8	Schnorr washer 8
4	3533	1	Casing assy.	23	1163	8	Hex. socket screw M8x22
5	3536	1	Spring 1x23.3x63	24	3521	2	Lid
6	3500	1	Fastener guide	25	73450	2	O-ring 17.17x1.78
7	3513	1	Axle	26	0225	2	Spring 0.9x6.9x24.1
8	3501	1	Spall guard	27	3522	1	Sear
9	3502	1	Flange	28	3535	1	Detent
10	3548	1	Hex skt screw M6x10.5	29	70489	2	Schnorr washer 6
11	3504	6	Retaining ring 17.5x1.6	30	72314	2	Hex. socket screw M6x60
12	3562	1	Adhesive label	31	3514	1	Firing pin guide
13	3534	6	Barrel 9x17	32	3529	1	Firing pin U
14	3520	1	Magazine cage assy.	33	2016908	1	Compression spring 1.6x14.7x51
15	3523	1	Housing	34	3528	1	Flange
16	3540	4	Hex skt screw M6x12	35	6148	1	Spring 0.4x7.4x31.8
17	3525	1	Grip frame	36	6161	1	Dowel pin 4 M6x30
18	3524	1	Spring support	37	6160	1	Spring 1.25x13x63
19	6151	1	Spring 1.4x14.9x42.4	38	8773	1	Set screw M8x8
				39	8771	1	Spring 0.63x5.5x12
				40	8753	1	Detent assy.
				41	3551	1	Spring clip assy.
				42	3561	1	Adhesive label Hilti UW 10
				43	3573	1	Nameplate UW 10 CIP

## 5. Safety precautions

Failure to observe these precautions could result in personal injury or accident.

1. Never use this tool unless you have received proper instruction on its safe use. For assistance, contact your local Hilti sales representative.
2. Always use this tool in strict accordance with the operating instructions and always keep them with the tool.
3. Do not point the tool at yourself or any bystander.
4. Never cock the tool against your hand or other part of your body. (The cocking force is low).



5. Never leave a loaded tool unattended. Always unload the tool before cleaning and servicing, storing at the end of the day, before works breaks, and before changing parts.
6. Operator and bystanders must wear appropriate eye protection and hard hats while the tool is in use. Wear ear protection when working in confined areas. (A neoprene hood over a diver's head is sufficient to protect the ears).
7. Always inspect the tool for proper operation before using. Do not use a tool that is incomplete or does not operate properly.
8. Keep the arms flexed when operating the tool ( do not stiffen arm). If you feel discomfort, discontinue use.
9. Always hold the tool perpendicular to work surface and base material when making fastening.
10. Always use genuine Hilti fasteners, cartridges and spare parts, or those of equivalent quality.
11. Do not attempt to pry a cartridge from the tool.



12. If a cartridge misfires or fails to ignite proceed as follows:

- Keep the tool pressed against work surface for 30 seconds. During this time, the trigger may be pulled as often as desired as further attempts to fire the tool.
- If cartridge still does not ignite, withdraw the tool from work surface taking care that it is not pointed at user or bystanders.
- Cycle the tool to transport the next cartridge to the firing position. Use up the cartridges remaining in the revolving magazine. Dispose of non-fired (misfired, live) cartridges in such a way that they can be neither used again nor misused.

13. Never make a fastening / never drive a stud into an existing hole or a stud already in place.

14. When fastening to concrete, a steel plate at least 3 mm thick must always be laid on the concrete surface and the stud then driven through it.

15. Always keep the tool and cartridges locked in a container and in a safe place when not in use.

16. Do not make fastenings in an explosive or flammable atmosphere, except where the tool is approved for such use.

17. Always consult the application guidelines.

18. The exceptionally high power of this tool and its high-velocity working principle make it necessary for suitable safety precautions to be taken where the tool is being used. If the tool is used wrongly, through-shots can occur. Consequently, make sure that no one is behind or beneath the place, point, component, etc. where the fastenings are being made.

Tests conducted to determine the free-flight behaviour of the studs showed that a stud will travel at least 1 m under water and at least 60 m above water.

All UW10 users / operators must have received special training.

19. The applicable national regulations, particularly those relating to accident prevention, must always be observed.

### 5.1 Tool safety devices

#### Contact pressure safety device / free-flying safety device

The tool cannot be fired until the cocking pressure and the cocking distance have been overcome.

#### Drop firing safety device

The tool cannot drop fire because of the cocking movement and the firing mechanism.

#### 7° till safety device

If the tool is tilted at an angle of more than 7° when cocked on the work surface, it cannot be fired.

### Spall guard safety device

The tool can only be fired when the spall guard is mounted.

### Transport safety

Transport safety feature is integrated into the tool design. There is only one configuration in which the tool can be fully cocked and fired. This configuration of tool parts is indicated by marks which are next to each other.

### Industrial safety information

#### References:

VBG 45

Working with high-velocity fastening tools (regulations)

DIN 7260, Part 1

Powder-actuated fastening tools (terms, design, markings)

### Type certification and exemptions

In accordance with §21 WaffV by the Physikalisch Technische Bundesanstalt (German authority). The tool class, caliber class and the PTB 933 test mark are incorporated in the type plate.

### 5.2 Noise information as per German legislation (3, GSGV dated January 18, 1991):

The noise power level  $L_{WA, 1S}$  as per § 1 (2) 1b) and, owing to the different places of working depending on the application, the measuring area noise pressure level,  $L_{pA, 1S}$  measured at a distance of 1 m as per § 1 (2) 1e), are given as well as the workplace-related emission figure according to the measuring standard. Operating condition and set-up conditions: Heaviest cartridge load to be used for the purpose with adapted stud, fired into a concrete block vertically downwards, measuring system in accordance with DIN 45635 part 34, "Measuring noise levels of powder-actuated tools".

Noise level (above water):

1b) Noise power level

$L_{WA, 1S} = 136 \text{ dB (A)}$

1e) Measuring area noise pressure level

$L_{pA, 1S} = 123 \text{ dB (A)}$

1b) Work-place related emission figure

$L_{pA, 1S} = 125 \text{ dB (A)}$

Different working conditions (particularly working underwater) can result in other noise emission values.

## 6. Manufacturer's warranty – DX Tools

en

Hilti warrants that the tool supplied is free of defects in material and workmanship. This warranty is valid so long as the tool is operated and handled correctly, cleaned and serviced properly and in accordance with the Hilti Operating Instructions, and the technical system is maintained. This means that only original Hilti consumables, components and spare parts, or other products of equivalent quality, may be used in the tool.

This warranty provides the free-of-charge repair or replacement of defective parts only over the entire lifespan of the tool. Parts requiring repair or replacement as a result of normal wear and tear are not covered by this warranty.

**Additional claims are excluded, unless stringent national rules prohibit such exclusion. In particular, Hilti is not obligated for direct, indirect, incidental or consequential damages, losses or expenses in connection with, or by reason of, the use of, or inability to use the tool for any purpose. Implied warranties of merchantability or fitness for a particular purpose are specifically excluded.**

For repair or replacement, send tool or related parts immediately upon discovery of the defect to the address of the local Hilti marketing organization provided.

This constitutes Hilti's entire obligation with regard to warranty and supersedes all prior or contemporaneous comments and oral or written agreements concerning warranties.

## 7. Operation

The consecutive numbers mentioned in the following description are identical with those in the drawing **1**.

### 7.1 Preparation prior for use

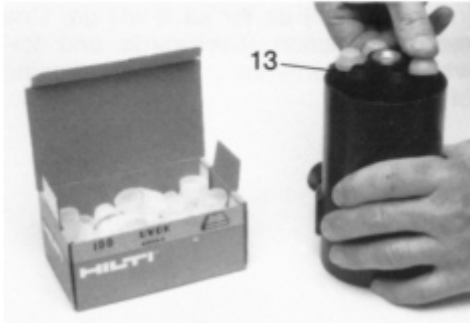
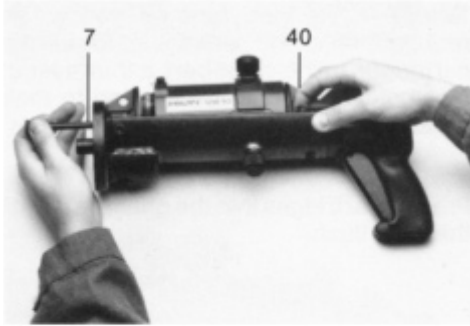

Fully withdraw axle (7) at the front end while pulling the detend (40) at the same time.

en

Remove revolving magazine (1).

### Loading operation

Put 6 sealing caps on the barrels (13) and press in tight. Sealing caps must always be used (above and below water).



Drop 6 studs point first in the opposite chamber ends. If the studs do not drop in completely press them with a second stud. If necessary, clean the cartridge chamber using a brush.



Take 6 cartridges (red or yellow, as required) out of the packaging. To seal the cartridges in the chambers a thin layer of Molycote 111 should be applied to their circumference.

Press 6 cartridges into the chambers until they are flush.

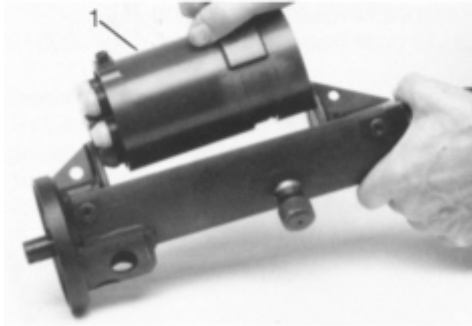

Put loaded revolving magazine (1) in semi-cylindrical space in top of tool. Make sure the white marks are not next to each other (transport safety).

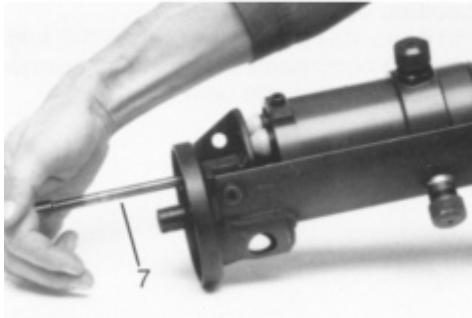

Insert axle (7) as far as it will go. One repeating action (backwards and forwards) will verify the correct functioning of the tool.

## 8. Before use

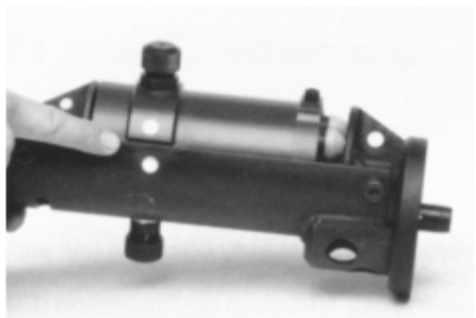

Hold the tool at right angles to the work surface and pull the trigger.

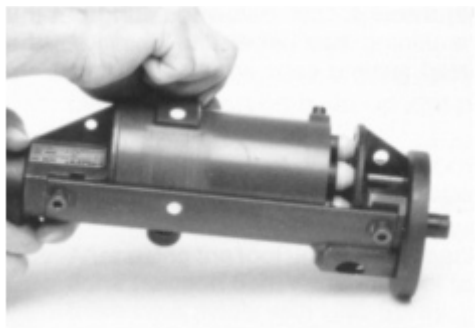

Basically, the tool should be transported with the two white marks away from each other i.e. in the safety position.

### **Unlocking the tool:**

The tool can be fired only when the white marks are positioned next to each other.

en

### **Cycling the tool:**

To cycle the tool, first turn the cycling knob to the left and then to the right, as far as possible each time.

## 9. Care and maintenance

en

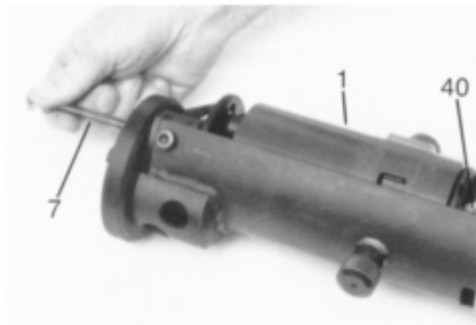

### 9.1 Operations after fastening

Withdraw the axle (7) again while releasing the detent (40). Remove the revolving magazine (1).

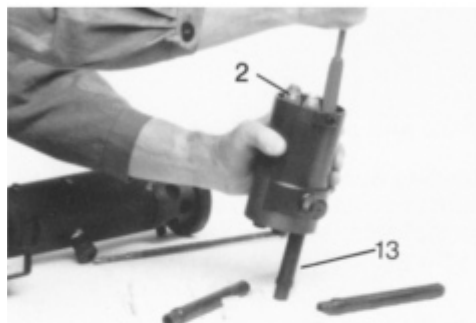

Holding the drum assy (2) over a soft surface e.g. a cloth, and working from the sealing cap end, push out the barrels (13) firmly using the grip end of the extractor. Push out two barrels (13) on each side of the screw and then rotate the drum assy (2) through 180° before pushing out the remaining two barrels. In doing so, the used sealing caps are also removed.



Eject spent cartridge cases using the ejector.



After reinserting the barrels (13) in the revolving magazine, the next loading operation can be begin immediately.

## 10. Maintenance

The consecutive numbers described in the following are identical with those in the drawing **1**.

### 10.1 Cleaning and servicing

#### Servicing schedule

No.	Task	Before first use	regularly after approx: 18 fasten-ings	30 fasten-ings	100 fasten-ings
1	Check for easy movement of moving parts: detent (28), revolving magazine (1), axle (7), trigger (3) and firing pin (32). If necessary, lubricate with Molycote 111.	●			●
2	Check all screws (23 + 30) are tight. If necessary, retighten.	●	●	●	●
3	Lubricate the barrels (13) and fastener guide (6) with Hilti-Spray.	●		●	●
4	Check for soiling and, if necessary, clean away carbon build-up and plastic residues.				●
5	After using the tool each time above water, clean the barrels (13) and the fastener guide (6), remove powder residues and lubricate the parts with Hilti-Spray.				
6	After using the tool underwater each time, take it apart according to the instructions (sections 12), rinse the tool parts in fresh water, dry them and lubricate them completely with Hilti-Spray. Grease the detent (28), axle (7) and firing pin (32) also with Molycote 111. Reassemble the tool according to the instructions (section 13).				

S-758 lubricating oil may also be used instead of Hilti lubricant spray (308976).

G-372 lubricating grease may also be used instead of Molycote 111 (3546).

en

# 11. Troubleshooting

## Possible faults and their elimination

No.	Fault	Probable cause	Remedy
1	Misfiring, firing pin indentation too small	Tool not pressed down enough or it is tilted	Press tool on surface again and pull trigger.
2		Cartridge misfiring	Cycle the tool and remove cartridges.
3		Firing pin spring (19) mixed up with contact spring (33)	Remove firing pin spring, compare with photo (section 6.4) and replace if necessary.
4		Not fully cycled, only half way	Cycle the tool, observe white marks!
5		Sealing cap missing	Press sealing cap on barrel
6	Difficult rotation of revolving magazine	Detent (28) stiff	Grease, shake tool
7		Sticking plastic parts	Shake the tool, remove the revolving magazine and parts. If necessary remove casing assembly.
8		Fastener guide sticking due to carbon dirt, sticking parts	Turn fastener guide, take off spall guard, remove fastener guide and compression spring. Clean and oil parts.
9		Bent axle	Straighten or replace it.
10		Barrel stays in housing	Clean, oil.
11	After the fastening operation, tool cannot be lifted away	Inadequate driving power, threaded stud jammed in fastener guide	Move tool back and forth and pull away sharply from work surface. Remove stud from the fastener guide.
		2 threaded studs in fastener guide because previous stud still in tool due to inadequate driving power	As above, if necessary, remove tool from work surface using lever. If necessary, replace fastener guide.
12	Axle stiff	No lubricant	Oil
		Bent axle	Straighten or replace it.
		Jammed parts	Clean
13	Studs do not drop fully into barrel	Fouled cartridge chamber, deformed stud guide sleeve	Clean with round brush, change stud.

en



## 12. Anleitung zur Demontage / Disassembly instructions / Démontage de l'appareil

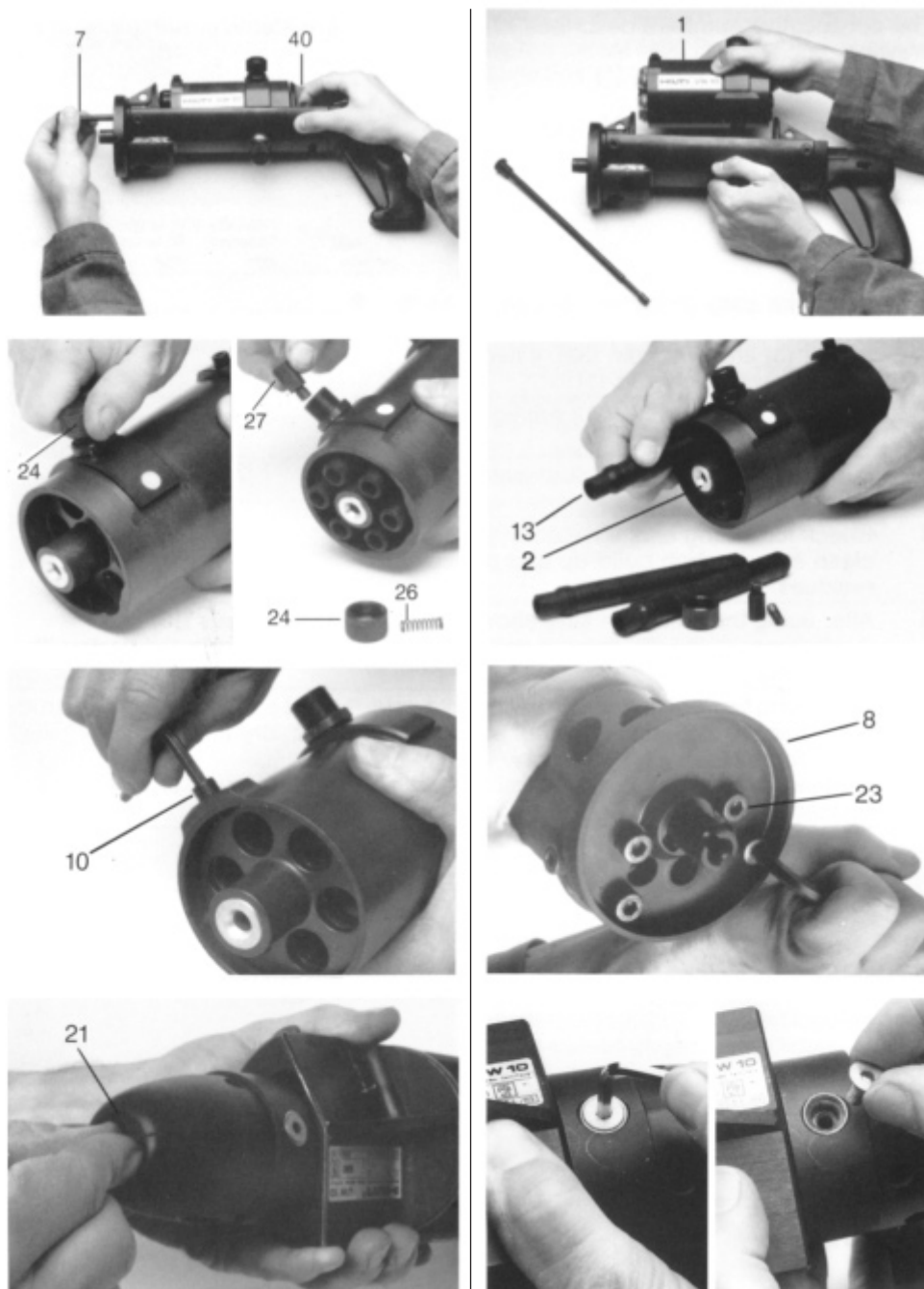

Die erwähnten Positions-Nummern sind identisch mit denjenigen auf Abbildung **1**

The consecutive numbers are identical to those in the drawing **1**

Les numéros de position évoqués sont identiques à ceux qui figurent sur l'illustration **1**

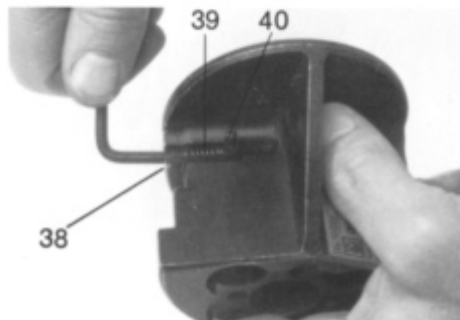
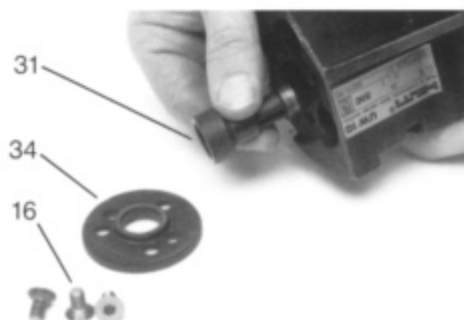
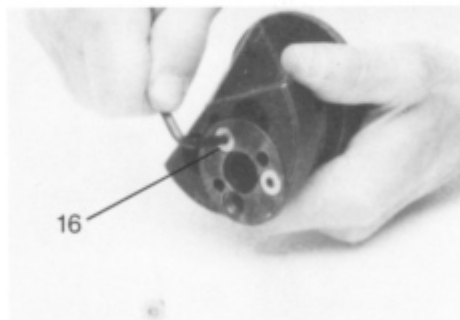
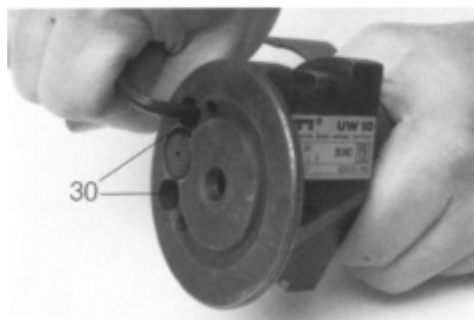
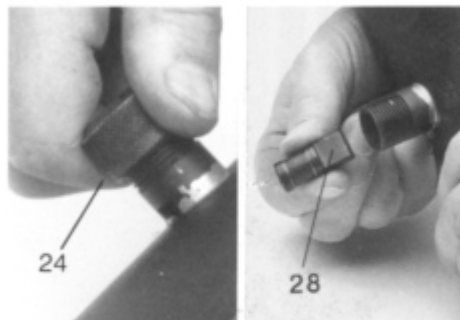
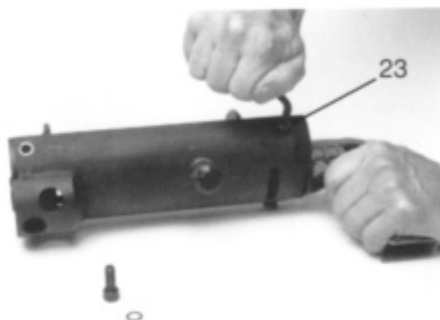
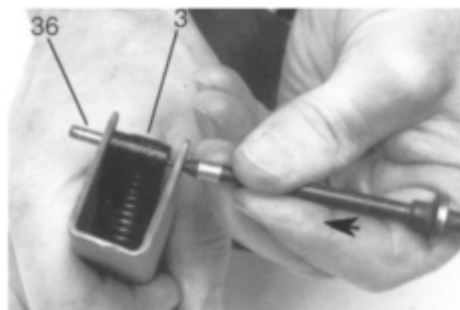
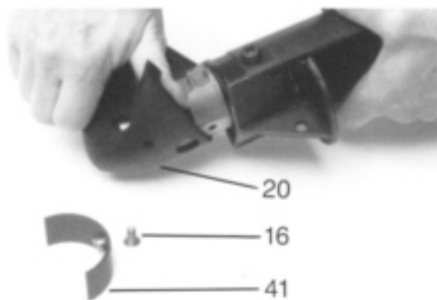

## 12.1 Übersicht Geräteteile / The parts of the tool / Vue de toutes les pièces de l'appareil démontées

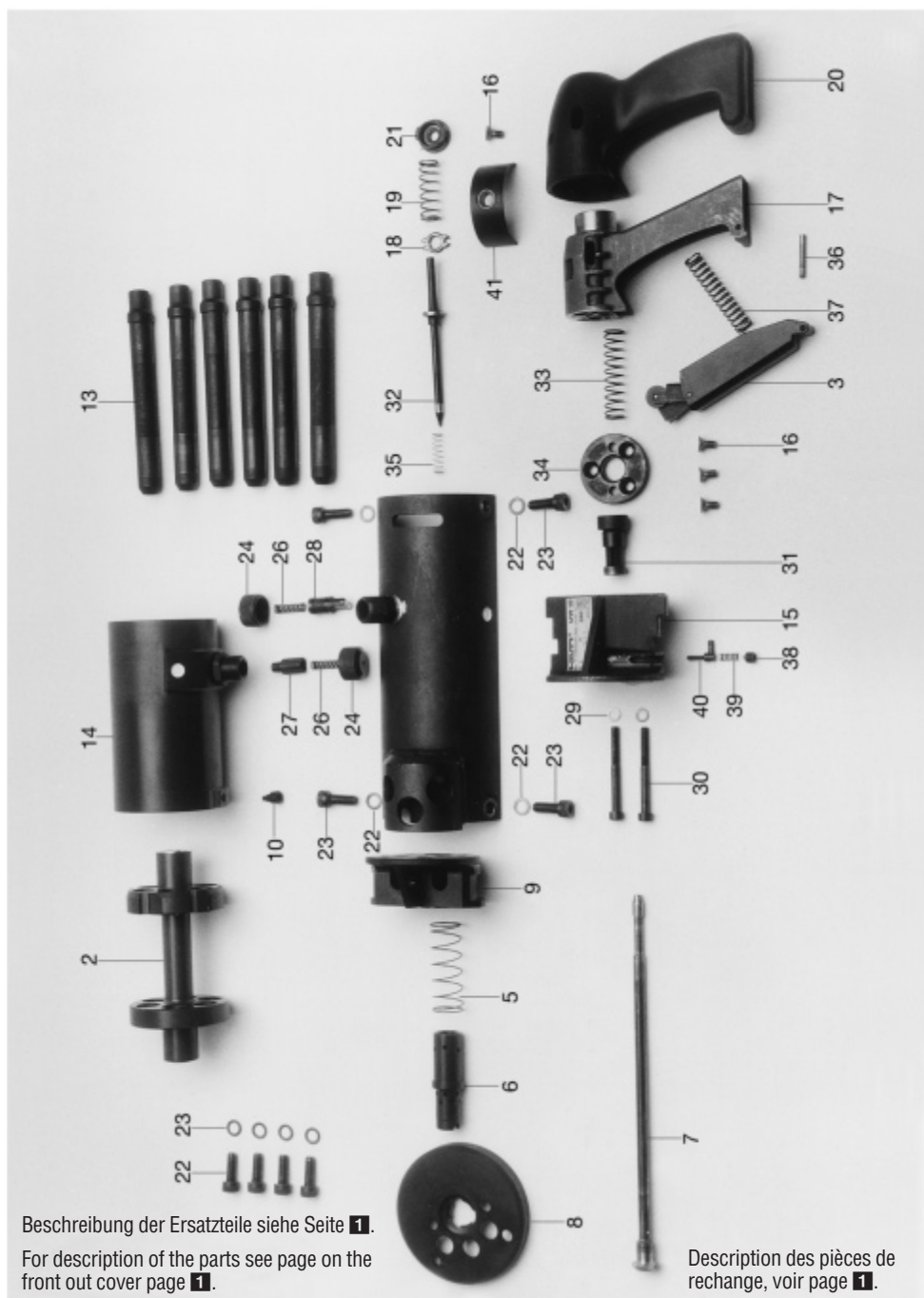

Beschreibung der Ersatzteile siehe Seite **1**.

For description of the parts see page on the front out cover page **1**.

Description des pièces de rechange, voir page **1**.

# 13. Anleitung zur Montage / Assembly instructions / Remontage de l'appareil

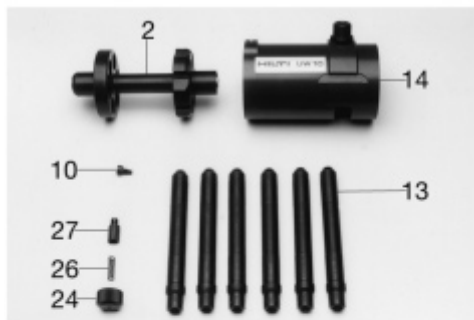

26 (Originalgröße)  
(Original size)  
(dimensions d'origine)

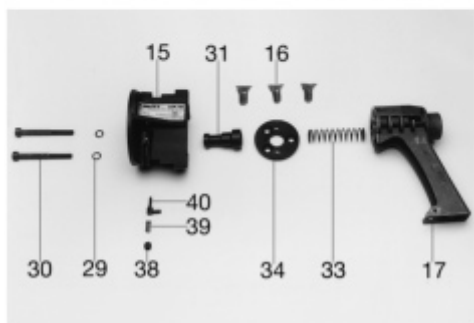

33 (Originalgröße)  
(Original size)  
(dimensions d'origine)



39 (Originalgröße)  
(Original size)  
(dimensions d'origine)

Die erwähnten Positions-Nummern sind identisch mit denjenigen auf Abbildung 1

The consecutive numbers are identical to those in the drawing 1

Les numéros de position évoqués sont identiques à ceux qui figurent sur l'illustration 1

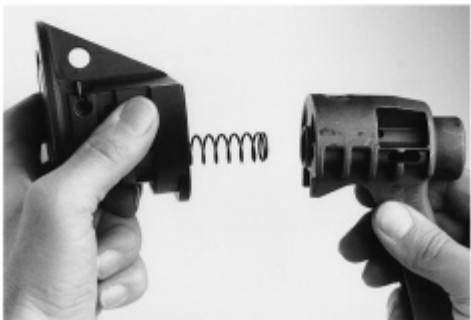
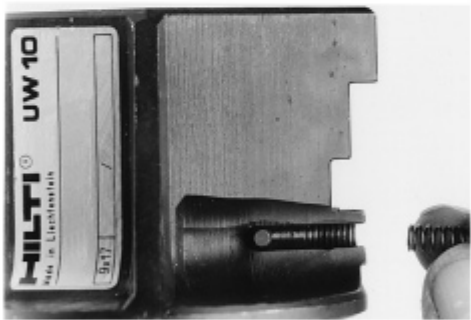
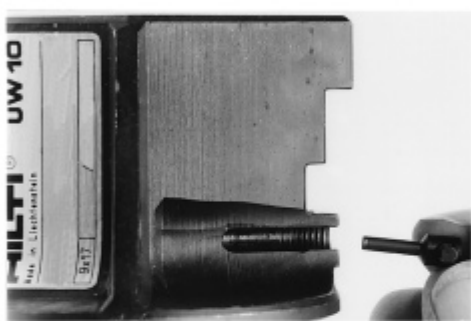
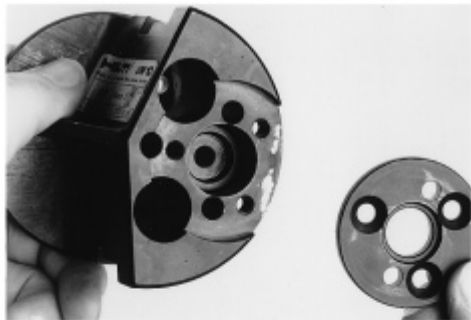

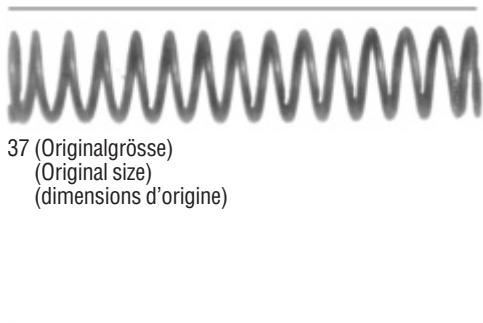
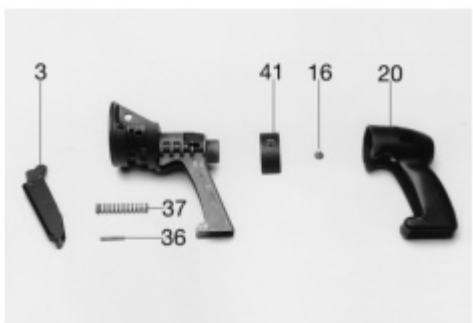



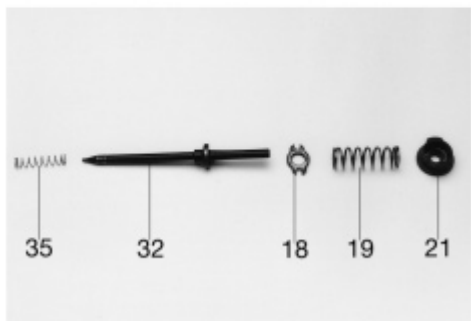

19 (Originalgröße), (Original size)  
(dimensions d'origine)



35 (Originalgröße), (Original size)  
(dimensions d'origine)

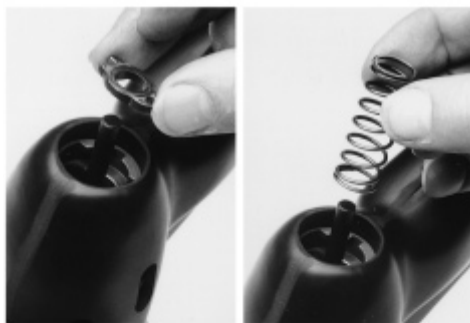

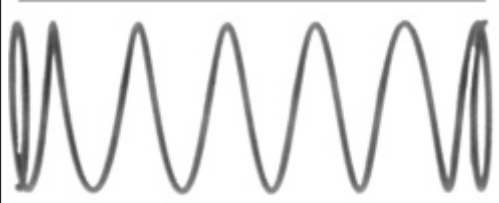
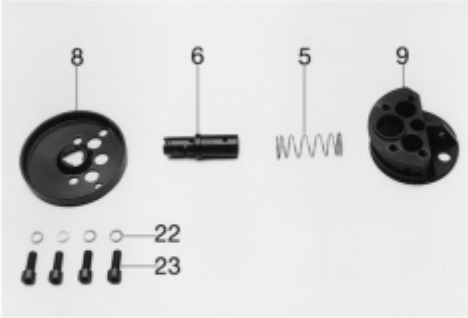

5 (Originalgröße)  
(Original size)  
(dimensions d'origine)

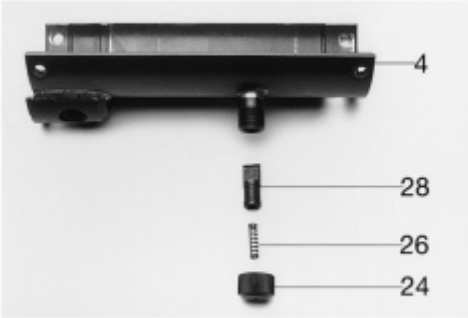
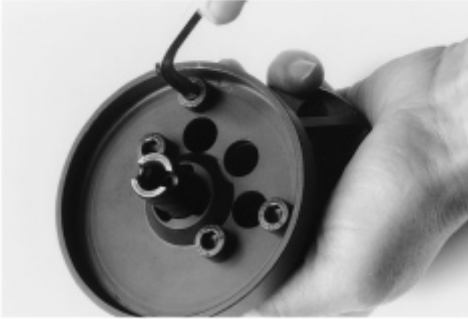
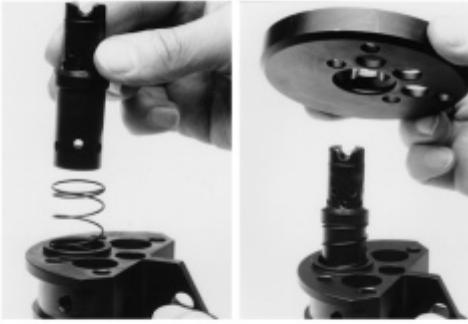

26 (Originalgröße)  
(Original size)  
(dimensions d'origine)



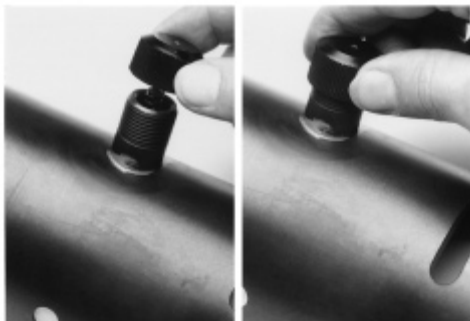
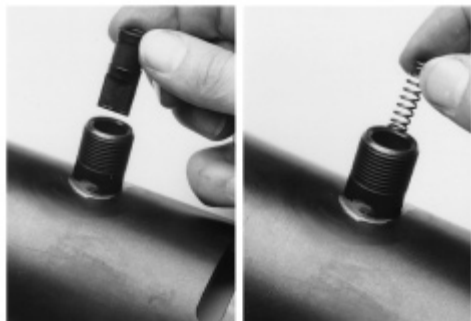



**Probesetzen:**

Gerät laden	siehe Seite 7
Setzen	siehe Seite 9
Entladen	siehe Seite 10

**Trial fastenings:**

Loading operation	see page 19
Fastening	see page 21
Unloading	see page 22

**Essais de tirs :**

Chargement de l'appareil,	voir page 31
Tirs,	voir page 33
Déchargement de l'appareil,	voir page 34



Hilti Corporation

LI-9494 Schaan

Tel.: +423 / 234 21 11

Fax: +423 / 234 29 65

[www.hilti.com](http://www.hilti.com)

Hilti = registered trademark of Hilti Corp., Schaan

W 1515 | 0712 | 00-Pos. 2 | 1

Printed in Liechtenstein © 2012

Right of technical and programme changes reserved S. E. & O.

3577 / A3



3577